



Security Engineered Machinery Co., Inc

OPERATIONAL & MAINTENANCE MANUAL

Model 7050P Old Style with Dual Troll Bin



POP-0027 Rev. 1
Revised: 01/27/2016

Security Engineered Machinery Co., Inc

NATIONWIDE SERVICE

Phone Toll Free 1(800)225-9293

Email: Service@SEMSHRED.COM

Fax: (508)366-6814

Website: WWW.SEMSHRED.com

TABLE OF CONTENTS

READ CAREFULLY BEFORE USE

This paper shredder is designed for the in-office destruction of paper documents to an unidentified waste. Proper care and use of our shredder will insure many years of trouble free operation.

Index-----	1
Safety Instructions & Application-----	2
Installation -----	3
Transportation / Pre-Assembly-----	4
Operating -----	5-7
Troubleshooting-----	8
Accessories/Technical Data-----	9
Recommended/Using and Ordering Spare Parts-----	10
Parts Breakdown-----	11-26
Wire Diagram-----	27-29

For NATIONWIDE SERVICE Call 1(800)225-9293

SAFETY INSTRUCTIONS

This instruction manual helps you learn the safe and comfortable operation of this machine. Before working with the machine please read these instructions carefully and consider the safety regulations.

Danger! Non-compliance with the instructions may endanger persons.

Warning! Non-compliance with the instructions may cause damage to the machine. The operating instructions must always be available for the operator

APPLICATION

The machine is capable of shredding loose and crumbled paper as well as cartons with staples. Due to material separation we recommend to avoid shredding plastic foils at the same time.

Danger!

- Only qualified persons are allowed to operate the machine
- Children should not operate the shredder
- Do not shred any strapping materials or fluids which can loop, splinter, chemically react or explode.

Warning!

- Feeding large steel components, rigid material, screws or nails will damage the shredding mechanism.

For NATIONWIDE SERVICE Call 1(800)225-9293

INSTALLATION

The machine is mounted on castors and easy to move. The machine must be installed on a firm, level dry floor.

Danger!

- The machine must not be used outside
- Do not use in the vicinity of flammable liquids or gasses
- Do not use in wet environments
- Protect the power cable from extreme heat, oil and sharp edges

Warning!

- Do not cover ventilation slits
- Follow the space assignment plan carefully (Below)
- Consider the floor loading, weight approximately 2630 lb (1200kg)

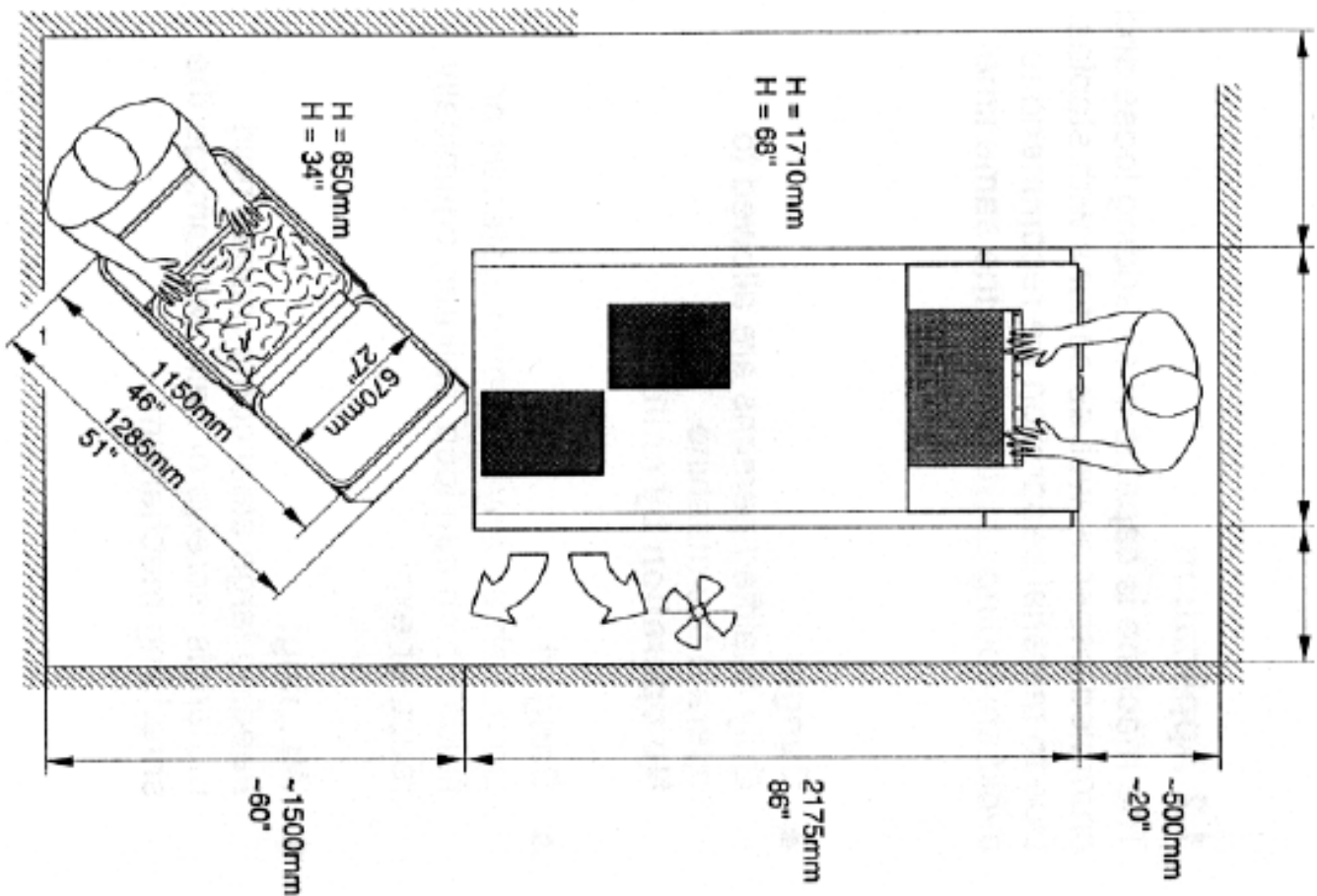

For NATIONWIDE SERVICE Call 1(800)225-9293

TRANSPORTATION

Attention!

- Do not raise the machine higher than necessary to avoid tipping
- Transport is only possible from the back and with built-in transport safety device (4) and (5).
- Make sure the lifting truck is centered under the machine.

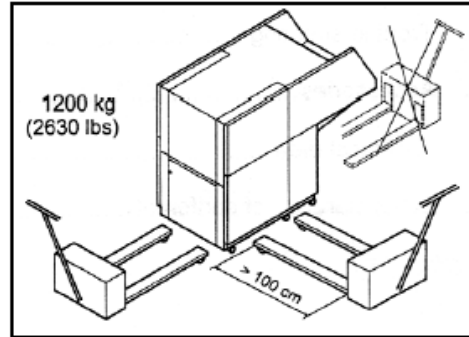
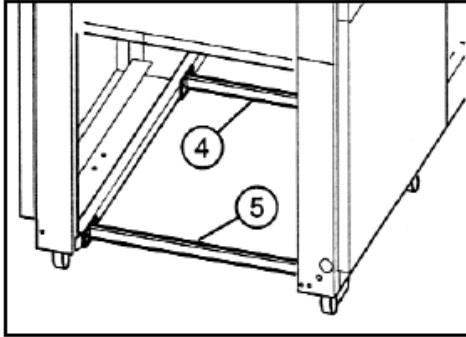

PRE-ASSEMBLY

- Open the door
- Remove the transport safety device (4) and (5) and keep for later transport use
- Mount the supporting screws(6)
- Screw down the supporting screws until the rear rolls are relieved

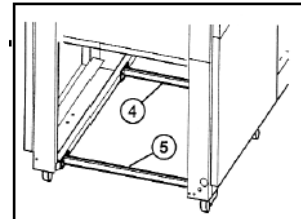

Mount the waste bin

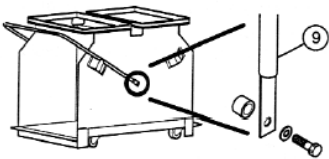

- Mount the shackle (9)
- Change both plastic bag (As described under changing the waste bag)
- Push the waste bin into the machine
- Close the door

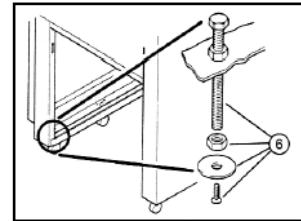

Power Supply

The name plate is located at the rear of the machine

- Data stated on the rating plate must correspond to the values of the power supply unit.
- Voltage "V" • Frequency "Hz" • Power Consumption "A"
- Earth Wire must be available • Connect the machine with the mains

For NATIONWIDE SERVICE Call 1(800)225-9293

PRE-ASSEMBLY Cont...

Checking Rotating Direction

Operate the machine for a short time as described under “Operation”

- The material is transported into the machine by the conveyor belt.

When the machine works in the opposite direction

As the machine is wired according to the IEC standardized rotary field, when changing the rotary direction we recommend that this is performed by an experienced specialist. The rotary direction may be changed by exchanging the “L1” and “L2” connections in the plug.

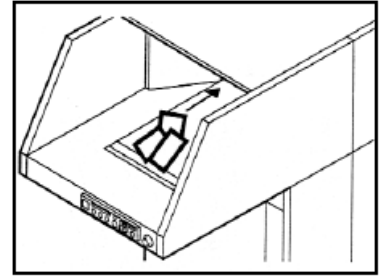

Danger! Incorrect exchange of the connections may endanger the operator.
In doubt, this work should be performed by an electrical specialist.

OPERATING

The machine will only run when door is closed!

Danger! The machine may only be operated by persons who have read and understand the operating instructions!

**Keep hands away from running shredding mechanism!
The shredding mechanism may cause serious injury!**

Operating Elements

1. Start
2. Stop and pilot light for door open
3. Reverse and the lamp waste bin full
4. Key switch
5. Standby
6. Main switch (can also be used as emergency off button)
7. Plot light temperature indicator
8. Emergency off

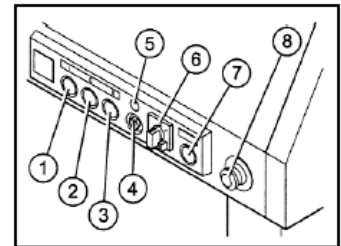

For NATIONWIDE SERVICE Call 1(800)225-9293

OPERATING Cont.....

Starting the Machine

Do not shred any material which may loop or splinter. Material, which does not go through the cutting head can only be pushed in with the pusher (9). In case of danger, press emergency off button (8).

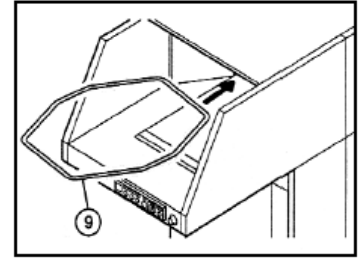

- Turn main switch (6) into position "I"
- Emergency button (8) must be unlocked (turn to the right)
- Turn on the key switch (4) turn to the right then the standby (5) illuminates
- Press and release the black button (1) conveyor belt is running
- Feed the paper over the total width of the conveyor belt

In case the quantity of material inserted is increased, the machine automatically changes to a more powerful and slower function. If this performance is still not sufficient the machine starts to reverse shortly and afterwards runs again forward. The machine switches between both speed levels until all material inserted is fully destroyed.

Attention! If possible let the machine work at its normal speed.
Shred continuous paper only in stacks

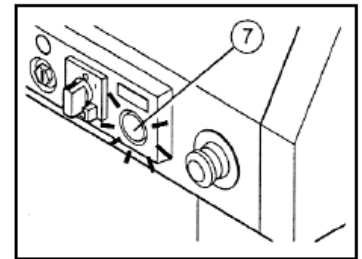

Stopping the machine

- Press the red key (2) or press the emergency "OFF" button (8)
- Keep hands away from the running shredding mechanism!**
- Yellow pilot light (7) appears, temperature of motor is too high (Decrease the material on the conveyor belt to make the machine work in normal speed)
 - Yellow pilot light (7) lights up, temperature is too high (wait approximately 10 to 20 minutes until motor cools down)

Stopping the Machine

For short breaks

- Press and release the red button (2) conveyor belt stops

For longer breaks

- Turn the main switch (6) to position "O" the entire machine shuts down
- Turn the key switch (4) and remove the key-now the machine is secured from unauthorized use

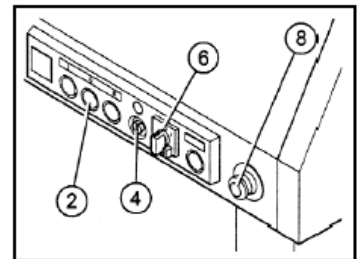

Changing the Waste Bag

If the lamp waste bag full lights up you should empty the waste bag.

- Open the door (9)
- Pull out the waste bin from the machine

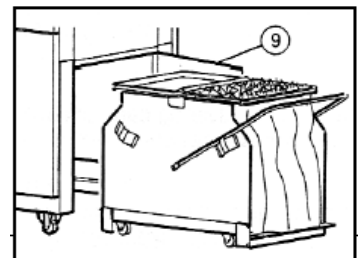

For NATIONWIDE SERVICE Call 1(800)225-9293

OPERATING Cont...

Changing the Waste Bag Cont...

If one of both bags is full

- Turn the handle (10) to empty waste bag
- Turn the waste bin and push it into the machine with full plastic bag in front
- Close the door (9)

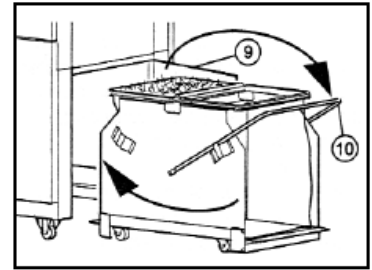

If both bags are full

- Remove the metal cover (11)
- Remove the round belt from the waste bag frame (12)
- Remove waste bags for storage on pallet.
- Tie the bags (for sealing parts and binding wires see accessories)
- Place a new bag into the bag frame and fold it down approximately 12" to 15" to the outside. Tighten the bag with the plastic band
- Fasten the bag with the round belt
- Attach the metal cover (11)
- Close the door
- Check the function of the door switch. Start the machine.
If the door is open the machine has to stop immediately

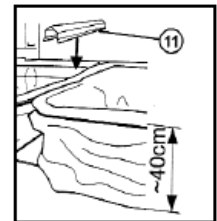
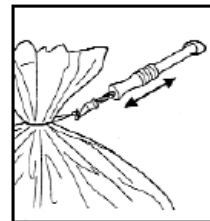
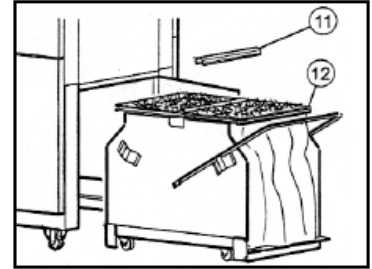

Note: Waste collection bags SEM part number for single bin - 6425B190 25/box
Waste collection bags SEM part number for dual troll bin -639B140A 50/box

Oiling the Shredding Mechanism

If the sheet capacity reduces or after bag is full we recommend that you oil the shredding mechanism:

- Move the lever (13) of the oil pump once
- After this lubrication please let the machine run several times Backwards and forwards alternately
- If the tank (14) is empty refill oil.
Type of oil: SEM Shred Oil #647OILHV (4 Gallon case)

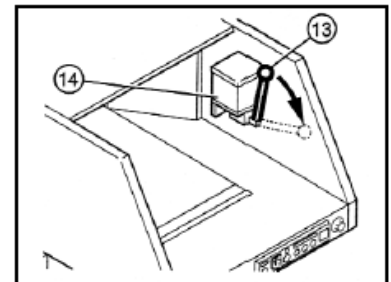

For NATIONWIDE SERVICE Call 1(800)225-9293

TROUBLESHOOTING

Danger! Disconnect from the mains before starting any service work or before removing the cover.

Malfunction: Standby (5) is not lighting up

Cause: The door is open
Main switch is OFF
The emergency button is pressed
Key switch is not plugged in
On-site fuse
Machine is overloaded the motor protection switch is re-activated after 10 minutes

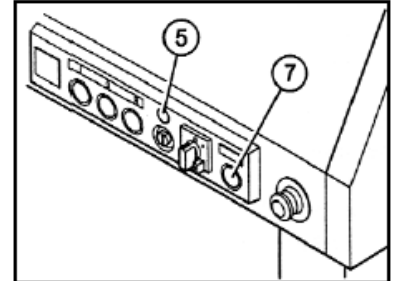

Malfunction: Motor makes a buzzing noise and the machine shows no performance

Cause: One phase is missing

Remedy: Check if all three phases are supplied with electric power (voltage) by an electrician

Malfunction: Machine door is difficult to open

Cause: Guiding bar of the lower cutting head cover is dirty

Remedy: Clean and grease the guiding bar

Malfunction: Machine switches off during normal operation

Cause: Bag full control light will light – Shred bag is full

Remedy: Change waste bag

Or

Cause: Yellow pilot light (7) lights up, temperature of the motor is too high

Remedy: Wait approximately 10 to 20 until machine cools down

For NATIONWIDE SERVICE Call 1(800)225-9293

ACCESSORIES

Pusher 9000 593

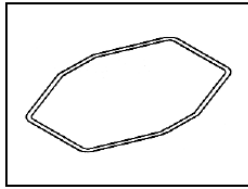

For closing the plastic bags: Locking device 9000 591
Binding wire (1000 pieces) 9000 597

Important: Only use manufacturer recommended accessories

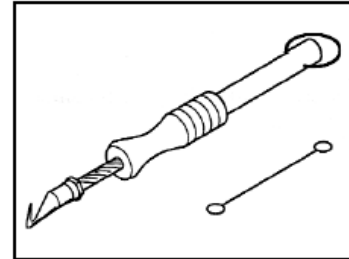

TECHNICAL DATA

Shred Capacity:	Up to 500 sheets
Shred Size:	5/16" x 3-1/8"
Speed:	45 FPM
Horsepower:	12-3/4HP (Dual drive 2 speed)
Dimensions:	67-1/2" H x 40-3/4" W x 85-1/2" D
Weight:	2500 lbs.
Power:	208V/230V 3 Phase

RECOMMENDED SPARE PARTS

Replacement Plastic Waste Bags #190 for single bin	Part Number 642B190 25/Box
Replacement Plastic Waste Bags #140 for dual troll bin	Part Number 639B140A 50/Box
Shredder Lubricating Oil 4 Gallon Case	Part Number 647OILHV

For NATIONWIDE SERVICE Call 1(800)225-9293

USING AND ORDERING SPARE PARTS

- Only use original SEM spare part replacements
- We guarantee their quality and functional reliability
- Warranty claims on parts and/or service must be approved by SEM's Customer Service Manager

Hints for Ordering Spare Parts

The spare parts shown on the following pages are designated by part numbers.

In order to avoid errors and the delivery of wrong parts, each parts order should contain the following information:

- Machine No. (See nameplate)
- Part No. and designation of desired spare parts
- Quantity of desired spare parts
- Desired mode of shipment (e.g. post, freight, express)
- Full billing & shipping addresses, including contact person & telephone

For NATIONWIDE SERVICE Call 1(800)225-9293